







※FEP管メーカー・継手メーカーに依り、削孔径は異なります。

30	40	50	65	80	100	125	150
 FEP30	 FEP40	 FEP50	 FEP65	 FEP80	 FEP100	 FEP125	 FEP150

工事名	なんでも継手Aタイプ (スパイラル形状用・未来工業社用) なんでも継手Bタイプ (スパイラル形状用・未来工業社用) その他 (削孔のみ)					
-----	--	--	--	--	--	--

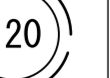
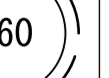
FEP管サイズ	削孔径	A	B	C	D	計
30	48					
40	60					
50	70					
65	85					
80	100					
100	120					
125	160					
150	180					
合計						

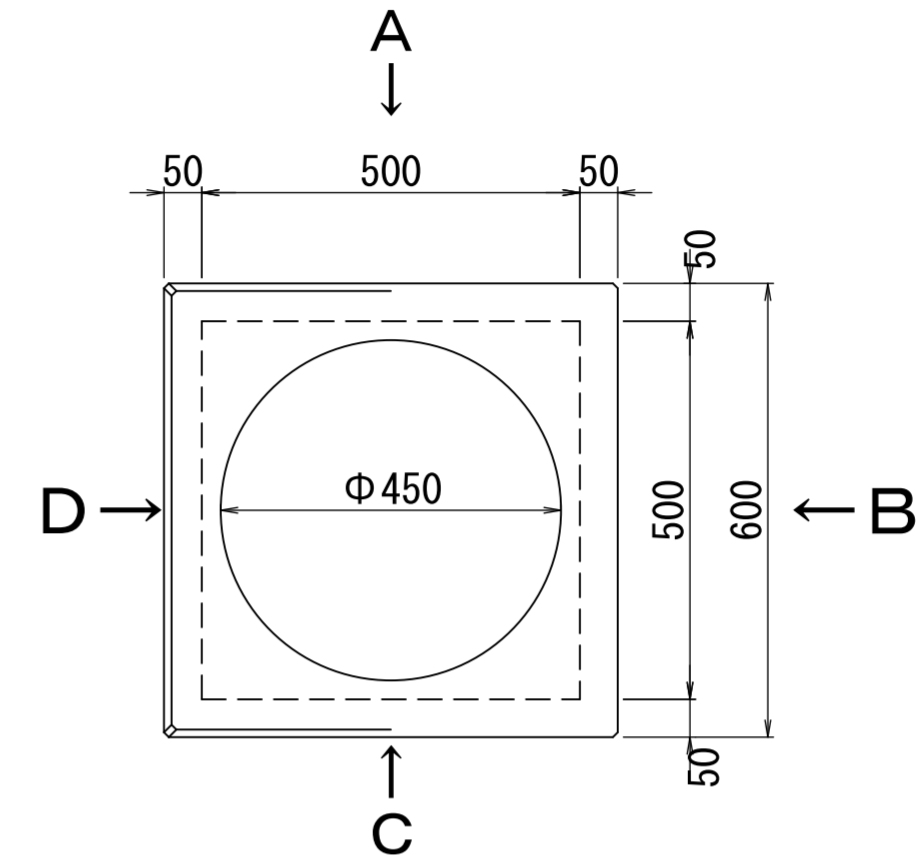
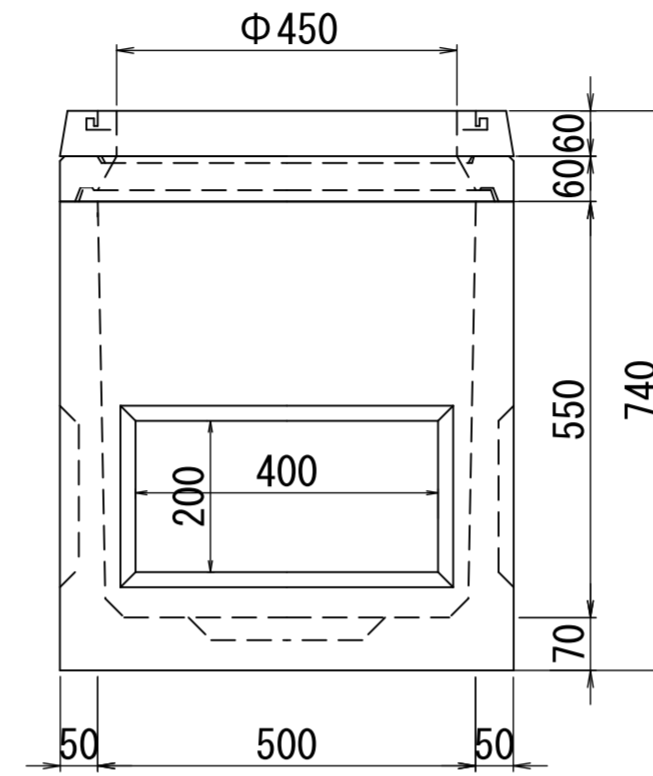

A

B

C

D

