







※FEP管メーカー・継手メーカーに依り、削孔径は異なります。

30	40	50	65	80	100	125	150
							
FEP30	FEP40	FEP50	FEP65	FEP80	FEP100	FEP125	FEP150

工事名	継手					
	なんでも継手Aタイプ (スパイラル形状用・未来工業社用)					
	なんでも継手Bタイプ (スパイラル形状用・未来工業社用)					
	その他 (削孔のみ)					

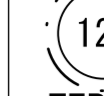
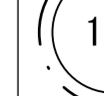
FEP管サイズ	削孔径	A	B	C	D	計
30	48					
40	60					
50	70					
65	85					
80	100					
100	120					
125	160					
150	180					
		合計				

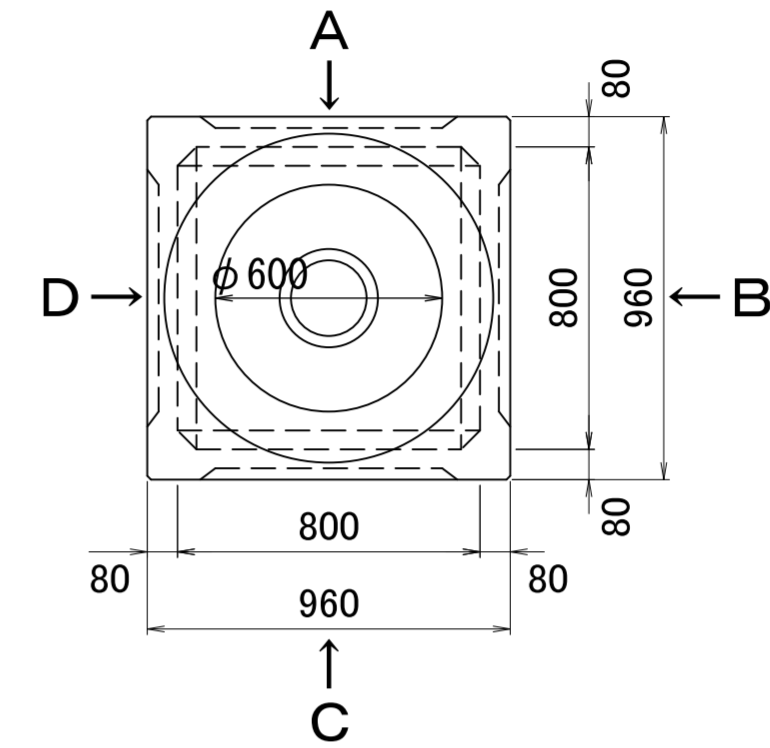
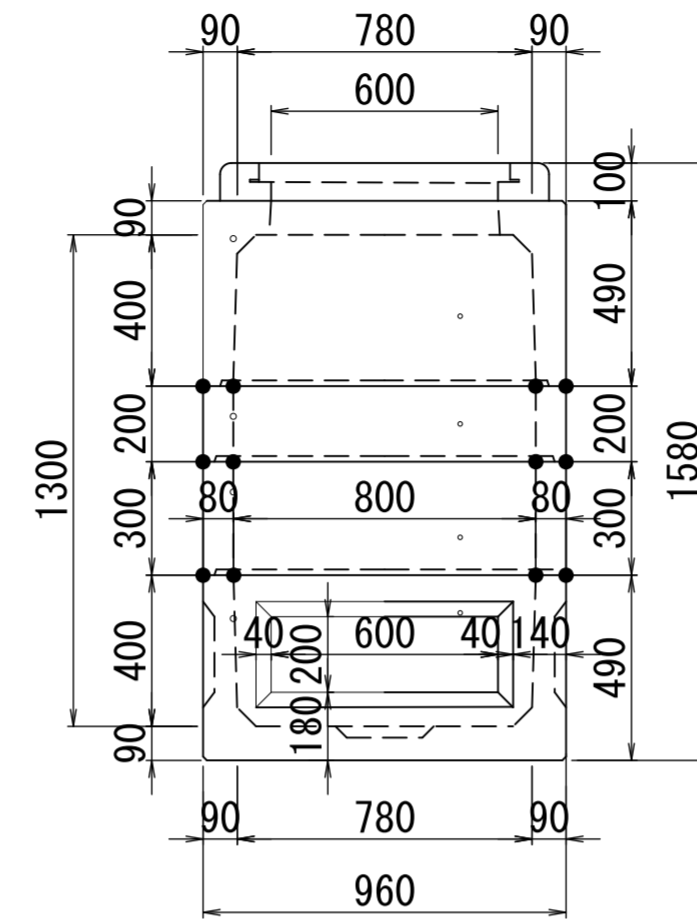

A

B

C

D

